

INSTRUCTION MANUAL

DEWALT®

D51276-XE

15 GAUGE 13 mm – 63.5 mm (1" – 2-1/2") ANGLED FINISH NAILER

D51257-XE

16 GAUGE 13 mm – 63.5 mm (1" – 2-1/2") STRAIGHT FINISH NAILER

EXTERNAL TOOL PARTS

D51276 15G. Angled Finish Nailer

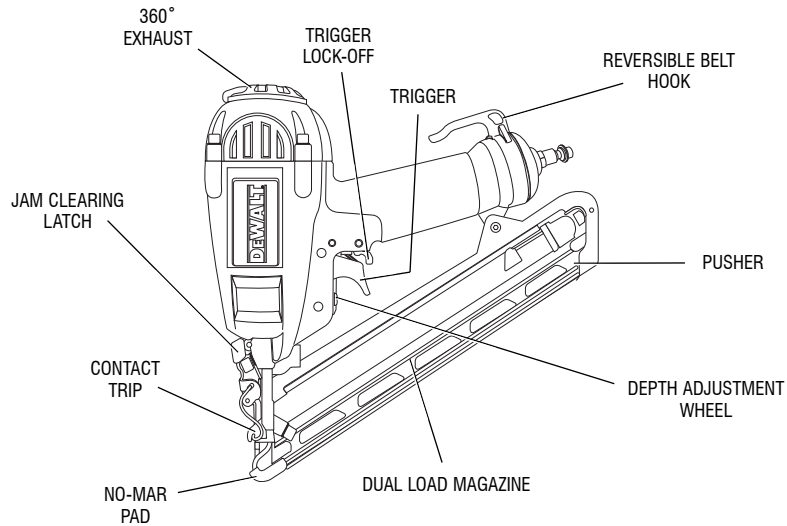

D51257 16G. Finish Nailer

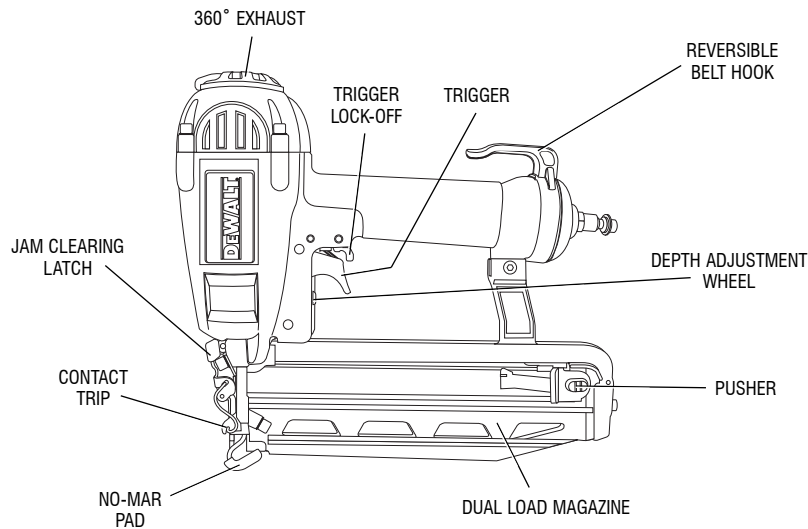

Definitions: Safety Guidelines

The definitions below describe the level of severity for each signal word. Please read the manual and pay attention to these symbols.

⚠ DANGER: Indicates an imminently hazardous situation which, if not avoided, **will** result in **death or serious injury**.

⚠ WARNING: Indicates a potentially hazardous situation which, if not avoided, **could** result in **death or serious injury**.

⚠ CAUTION: Indicates a potentially hazardous situation which, if not avoided, **may** result in **minor or moderate injury**.

CAUTION: Used without the safety alert symbol indicates a potentially hazardous situation which, if not avoided, **may** result in **property damage**.

TOOL SPECIFICATIONS

	D51257 16G. Finish Nailer	D51276 15G. Angled Finish Nailer
Height	10.7" (272.0 mm)	11.6" (294.1 mm)
Width	3.5" (88.9 mm)	3.5" (88.9 mm)
Length	11.8" (299.2 mm)	13" (330.2 mm)
Weight	3.9 lbs. (1.77 kg)	3.85 lbs. (1.75 kg)
Recommended Operating Pressure	70 - 120 psig (4.9 to 8.3 bar)	70 - 120 psig (4.9 to 8.3 bar)
Air consumption per 100 cycles	4.5 cfm @ 100 psi 127 l/m @ 6.9 bar	6.0 cfm @ 100 psi 170 l/m @ 6.9 bar
Loading capacity	100 Nails	100 Nails

NAIL SPECIFICATIONS

	D51257 16G. Finish Nailer	D51276 15G. Angled Finish Nailer
Nail Lengths	2" - 3-1/2" (50 mm - 90 mm)	2" - 3-1/2" (50 mm - 90 mm)
Shank Diameters	.16 gauge	15 gauge
Nail Stick Angles	straight	34°

IF YOU HAVE ANY QUESTIONS OR COMMENTS ABOUT THIS OR ANY DEWALT TOOL, CALL US AT: **1800 654 155** (Aust) or **0800 339258** (NZ).

SAFETY INSTRUCTIONS FOR POWER TOOLS

When using power tools, always observe the safety regulations applicable in your country to reduce the risk of fire, electric shock and personal injury. Read the following safety instructions before attempting to operate this product. Keep these instructions in a safe place.

GENERAL POWER TOOL SAFETY WARNINGS

⚠ WARNING! Read all safety warnings and all instructions. Failure to follow the warnings and instructions may result in electric shock, fire and/or serious injury.

SAVE ALL WARNINGS AND INSTRUCTIONS FOR FUTURE REFERENCE

Important Safety Instructions for Pneumatic Tools

⚠ WARNING: When using any pneumatic tool, all safety precautions, as outlined below, should be followed to avoid the risk of death or serious injury. Read and understand all instructions before operating the tool.

- **Actuating tool may result in flying debris, collation material, or dust which could harm operator's eyes.** The operator and all those persons in the general area should wear safety glasses with permanently attached side shields. Approved safety glasses are imprinted with the characters "Z87.1". It is the employer's responsibility to enforce the use of eye protection equipment by the tool operator and other people in the work area. (Fig. A)
- **Minimize flying dust and debris** by rotating 360° exhaust to appropriate setting.
- **Always wear appropriate personal hearing and other protection during use.** Under some conditions and duration of use, noise from this product may contribute to hearing loss. (Fig. A)
- **Use only clean, dry, regulated air.** Condensation from an air compressor can rust and damage the internal workings of the tool. (Fig. B)
- **Regulate air pressure. Use air pressure compatible with ratings on the nameplate of the tool.** (Not to exceed 120 psi, 8.3 bar) Do not connect the tool to a compressor rated at over 175 psi. The tool operating pressure must never exceed 175 PSI even in the event of regulator failure. (Fig. C)
- **Only use air hose that is rated for a maximum working pressure of at least 150 PSI (10.3 BAR) or 150% of the maximum system pressure, which ever is greater.** (Fig. D)
- **Do not use bottled gases to power this tool.** Bottled compressed gases such as oxygen, carbon dioxide, nitrogen, hydrogen, propane, acetylene or air are not for use with pneumatic tools. Never use combustible gases or any other reactive gas as a

FIG. A



FIG. B

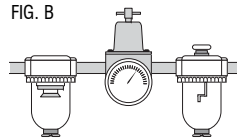

FIG. C

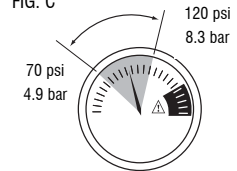

FIG. D



FIG. E

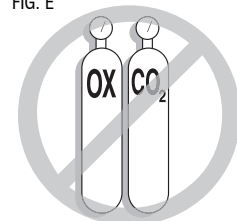
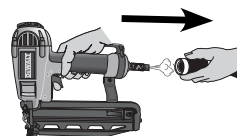

FIG. F



power source for this tool. Danger of explosion and/or serious personal injury may result. (Fig. E)

- **Use couplings that relieve all pressure from the tool when it is disconnected from the power supply.** Use hose connectors that shut off air supply from compressor when the tool is disconnected. (Fig. F)
- **Disconnect tool from air supply when not in use. Always disconnect tool from air supply and remove fasteners from magazine before leaving the area or passing the tool to another operator. Do not carry tool to another work area in which changing location involves the use of scaffoldings, stairs, ladders, and the like, with air supply connected. Do not make adjustments, remove magazine, perform maintenance or clear jammed fasteners while connected to the air supply.** If the contact trip is adjusted when the tool is connected to the air supply and nails are loaded, accidental discharge may occur. (Fig. G)
- **Connect tool to air supply before loading fasteners, to prevent a fastener from being fired during connection.** The tool driving mechanism may cycle when tool is connected to the air supply. Do not load fasteners with trigger or contact trip depressed, to prevent unintentional firing of a fastener.
- **Do not remove, tamper with, or otherwise cause the tool, trigger, or contact trip to become inoperable.** Do not tape or tie trigger or contact trip in the on position. Do not remove spring from contact trip. Make daily inspections for free movement of trigger and contact trip. Uncontrolled discharge could result.
- **Inspect tool before use. Do not operate a tool if any portion of the tool, trigger, or contact trip is inoperable, disconnected, altered, or not working properly.** Leaking air, damaged parts or missing parts should be repaired or replaced before use. (Fig. H)
- **Do not alter or modify the tool in any way.** (Fig. I)
- **Always assume that the tool contains fasteners.**
- **Do not point the tool at co-workers or yourself at any time.** No horseplay! Work safe! Respect the tool as a working implement. (Fig. J)
- **Keep bystanders, children, and visitors away while operating a power tool.** Distractions can cause you to lose control. When tool is not in use, it should be locked in a safe place, out of the reach of children.
- **Remove finger from trigger when not driving fasteners. Never carry tool with finger on trigger.** Accidental discharge could result. Using the trigger lock-off will prevent accidental discharge.
- **Do not overreach.** Maintain proper footing and balance at all times. Loss of balance may cause personal injury. (Fig. K)

FIG. G

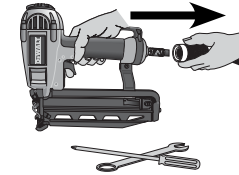

FIG. H

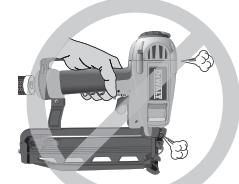

FIG. I



FIG. J



FIG. K



FIG. L

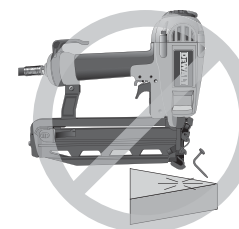

- **Make sure hose is free of obstructions or snags.** Entangled or snarled hoses can cause loss of balance or footing.
- **Use the tool only for its intended use. Do not discharge fasteners into open air, concrete, stone, extremely hard woods, knots or any material too hard for the fastener to penetrate. Do not use the body of the tool or top cap as a hammer.** Discharged fasteners may follow unexpected path and cause injury. (Fig. L)
- **Always keep fingers clear of contact trip to prevent injury from inadvertent release of nails.** (Fig. M)
- **Refer to the Maintenance and Repairs sections for detailed information on the proper maintenance of the tool.**
- **Always operate the tool in a clean, lighted area.** Be sure the work surface is clear of any debris and be careful not to lose footing when working in elevated environments such as rooftops.
- **Do not drive fasteners near edge of material.** The workpiece may split causing the fastener to ricochet, injuring you or a co-worker. Be aware that the nail may follow the grain of the wood (shiner), causing it to protrude unexpectedly from the side of the work material. Drive the nail perpendicular to the grain to reduce risk of injury. (Fig. N)
- **Do not drive nails onto the heads of other fasteners or with the tool at too steep an angle.** Personal injury from strong recoil, jammed fasteners, or ricocheted nails may result. (Fig. O)
- **Be aware of material thickness when using the nailer.** A protruding nail may cause injury.
- **Be aware that when the tool is being utilized at pressures on the high end of its operating range, nails can be driven completely through thin or very soft work material.** Make sure the pressure in the compressor is set so that nails are set into the material and not pushed completely through. (Fig. P)
- **Keep hands and body parts clear of immediate work area.** Hold workpiece with clamps when necessary to keep hands and body out of potential harm. Be sure the workpiece is properly secured before pressing the nailer against the material. The contact trip may cause the work material to shift unexpectedly. (Fig. Q)
- **Do not use tool in the presence of flammable dust, gases or fumes.** The tool may produce a spark that could ignite gases causing a fire. Driving a nail into another nail may also cause a spark. (Fig. R)
- **Keep face and body parts away from back of the tool cap when working in restricted areas.** Sudden recoil can result in impact to the body, especially when nailing into hard or dense material. (Fig. S)
- **Grip tool firmly to maintain control while allowing tool to recoil away from work surface as fastener is driven.** In "Contact Actuation Mode" if contact trip is

allowed to recontact work surface before trigger is released an unwanted fastener will be fired.

- **Choice of triggering method is important.** Check the manual for triggering options.

BUMP ACTION TRIGGER

- **When using the bump action trigger, be careful of unintentional double fires resulting from tool recoil.** Unwanted fasteners may be driven if the contact trip is allowed to accidentally re-contact the work surface. (Fig. T)

TO AVOID DOUBLE FIRES:

- Do not engage the tool against the work surface with a strong force.
- Allow the tool to recoil fully after each actuation.
- Use sequential action trigger.
- **When “bump” actuating the framing nailer, always keep tool in control.** Inaccurate placement of tool can result in misdirected discharge of a fastener.

SEQUENTIAL ACTION TRIGGER

- **When using the sequential action trigger, do not actuate the tool unless the tool is placed firmly against the workpiece.**
- **DEPTH ADJUSTMENT:** To reduce risk of serious injury from accidental actuation when attempting to adjust depth, **ALWAYS:**
 - Lock OFF trigger.
 - Disconnect air supply.
 - Avoid contact with trigger during adjustments.
- **Do not drive nails blindly into walls, floors or other work areas.** Fasteners driven into live electrical wires, plumbing, or other types of obstructions can result in injury. (Fig. U)
- **Stay alert, watch what you are doing and use common sense when operating a power tool. Do not use tool while tired or under the influence of drugs, alcohol, or medication.** A moment of inattention while operating power tools may result in serious personal injury.

⚠ WARNING: Some dust created by power sanding, sawing, grinding, drilling, and other construction activities contains chemicals known to the State of California to cause cancer, birth defects or other reproductive harm. Some examples of these chemicals are:

- lead from lead-based paints,
- crystalline silica from bricks and cement and other masonry products, and
- arsenic and chromium from chemically-treated lumber.

FIG. M



FIG. N

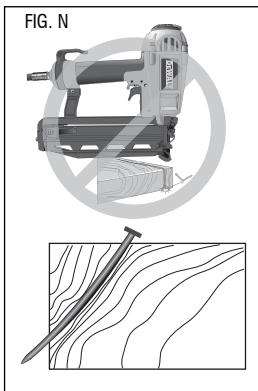

FIG. O

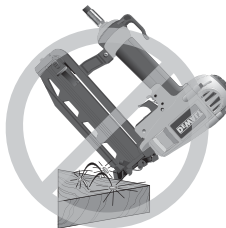

FIG. P

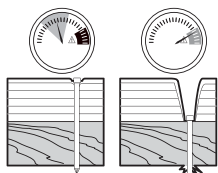
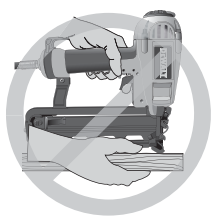

FIG. Q



Your risk from these exposures varies, depending on how often you do this type of work. To reduce your exposure to these chemicals: work in a well ventilated area, and work with approved safety equipment, such as those dust masks that are specially designed to filter out microscopic particles.

⚠ WARNING: ALWAYS use safety glasses. Everyday eyeglasses are NOT safety glasses. Also use face or dust mask if cutting operation is dusty. **ALWAYS WEAR CERTIFIED SAFETY EQUIPMENT:**

- ANSI Z87.1 eye protection (CAN/CSA Z94.3),
- ANSI S12.6 (S3.19) hearing protection,
- NIOSH/OSHA/MSHA respiratory protection.

BEFORE OPERATING THIS TOOL, CAREFULLY READ AND UNDERSTAND ALL INSTRUCTIONS IN THE “IMPORTANT SAFETY INSTRUCTIONS” SECTION.

Additional Safety Instructions For Australia And New Zealand

For Australia and New Zealand, nailers are supplied with full sequential action trigger (/ gray) only .

The bump fire trigger (// black) is available as an optional only for use in industry requiring bump fire (e.g. pallet manufacture).

- **Young children and the infirm.** This appliance is not intended for use by young children or infirm persons without supervision. Young children should be supervised to ensure that they do not play with this appliance.

BEFORE OPERATING THIS TOOL, CAREFULLY READ AND UNDERSTAND ALL INSTRUCTIONS IN THE “IMPORTANT SAFETY INSTRUCTIONS” SECTION.

ASSEMBLY

⚠ WARNING: Lock off trigger, disconnect air line from tool and remove fasteners from magazine before making adjustments or personal injury may result.

Trigger

⚠ WARNING: Keep fingers AWAY from trigger when not driving fasteners to avoid accidental firing. Never carry tool with finger on trigger. In “Contact Bump Actuation Mode” tool will fire a fastener if safety is bumped while trigger is depressed.

In accordance with the ANSI Standard SNT-101-2002, the DEWALT Nailers are assembled with a sequential action trigger. For a replacement trigger contact your authorized service center or call (AUS) 1800 654 155 or (NZ) 0800 339258.

FIG. R



FIG. S

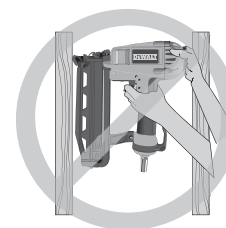

FIG. T

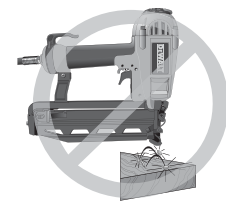
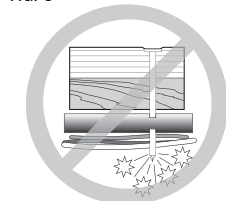

FIG. U



The **gray trigger** with / imprinted on the side, (Cat.# D510023 kit) is the single sequential action trigger and causes the tool to operate in this mode.

The **black trigger** with // imprinted on the side, (Cat.# D510020 kit) is the bump action trigger and permits the tool to be actuated in this manner.

For defining the use of the **sequential action trigger** and **bump action trigger**, see the **Actuating Tool** section of this manual.

FIG. 2

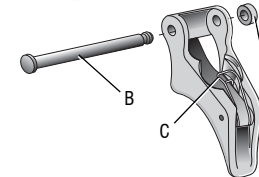

TRIGGER REMOVAL (FIG. 2)

1. Lock off trigger.
2. Remove air from the tool.
3. Remove rubber grommet (A) from end of dowel pin (B).
4. Remove dowel pin.
5. Remove trigger assembly from trigger cavity under the handle of the tool housing.

FIG. 3

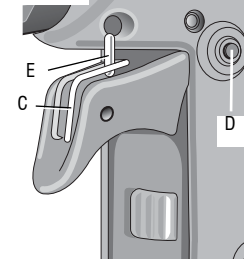

TRIGGER INSTALLATION (FIG. 3)

1. Select either the sequential or bump action trigger to be installed on the tool. Both triggers are included in the tool packaging.
2. Insert the trigger kit into trigger cavity.
3. Ensure that trigger spring (C) is placed around the trigger valve stem (E).
4. Align the holes of the trigger with the housing holes (D), then insert the dowel pin (B) through the entire assembly as shown.
5. Push the rubber grommet (A) onto the end of the dowel rod as shown.

Air Fitting

The DEWALT framing nailers have a standard 3/8" pipe thread for the air fitting. The tool is assembled with a 3/8" to 1/4" adapter installed in the end cap.

TO INSTALL AN AIR FITTING

1. Wrap the male end of the fitting with sealing tape prior to assembly to eliminate air leaks.
2. **To install a 1/4" fitting:** screw the fitting into the 3/8" to 1/4" adapter in the end cap of the tool and tighten firmly.
3. **To install a 3/8" fitting:** screw it directly into the end cap. If an adapter is in the end cap, remove it prior to inserting the fitting.

OPERATION

Preparing the Tool

▲ WARNING: Read the section titled *Important Safety Instructions for Pneumatic Tools* at the beginning of this manual. Always wear eye and ear protection when operating this tool. Keep the nailer pointed away from yourself and others. For safe operation, complete the following procedures and checks before each use of the nailer.

NOTE: These nailers are designed to be used without oil. If preferred, 5–7 drops of oil may be used on o-rings, rubber parts and can be applied to the air fittings.

CAUTION: To reduce the risk of damage to the tool, only use DeWALT Pneumatic Tool Oil or a non-detergent S.A.E. 20 weight oil. Oil with additives or detergent will damage tool parts.

1. Before you use the nailer, be sure that the compressor tanks have been properly drained.
2. Wear proper eye, hearing and *respiratory protection*.
3. Lock the pusher in the back position and remove all fasteners from the magazine.
4. Check for smooth and proper operation of contact trip and pusher assemblies. Do not use tool if either assembly is not functioning properly. NEVER use a tool that has the contact trip restrained in the up position.
5. Check air supply. Ensure that air pressure does not exceed recommended operating limits; 70 to 120 psi, (4.9 to 8.3 bar, 5 to 8.5 kg/cm²).
6. Connect air hose.
7. Check for audible leaks around valves and gaskets. Never use a tool that leaks or has damaged parts.

▲ WARNING: To reduce the risk of personal injury, disconnect tool from air supply before performing maintenance, clearing a jammed fastener, leaving work area, moving tool to another location or handing the tool to another person.

FIG. 4

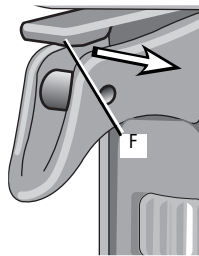

Using the Lock-off (Fig. 4)

▲ WARNING: To reduce the risk of injury, ALWAYS wear proper eye [ANSI Z87.1 (CAN/CSA Z94.3)] and hearing protection [ANSI S12.6 (S3.19)] when operating this tool.

▲ WARNING: Do not keep trigger depressed when tool is not in use. Keep the lock-off switch rotated to the right (OFF) when the tool is not in use. Serious personal injury may result.

▲ WARNING: Lock off trigger, disconnect air line from tool and remove fasteners from magazine before making adjustments or personal injury may result.

Each DeWALT nailer is equipped with a trigger lock-off switch (F) which when rotated to the right, prevents the tool from actuating. When the switch is centered, the tool will be fully operational. The trigger should always be locked off whenever any adjustments are made or when tool is not in use.

Loading the Tool

▲ WARNING: Keep the tool pointed away from yourself and others. Serious personal injury may result.

▲ WARNING: Never load nails with the contact trip or trigger activated. Personal injury may result.

FIG. 5

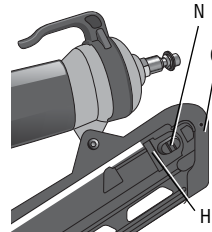

The DeWALT finish nailers are equipped with dual load magazines. The fasteners can be loaded using one of two methods:

LOAD AND LOCK METHOD (FIG. 5)

1. Lock off trigger.
2. Insert fasteners into the rear of the magazine (G).
3. Pull pusher (H) back until the nail follower falls behind the nails.

LOCK AND LOAD METHOD

1. Lock off trigger.
2. Pull pusher back until it locks in the the pusher latch.
3. Insert fasteners into the rear of the magazine.
4. Press the pusher button (N) to release and allow the nail follower (H) to fall behind the nails.

Actuating Tool

▲ WARNING: To reduce the risk of injury, ALWAYS wear proper eye [ANSI Z87.1 (CAN/CSA Z94.3)] and hearing protection [ANSI S12.6 (S3.19)] when operating this tool.

The tool can be actuated using one of two modes: single sequential action trigger mode and bump action trigger mode. The trigger installed on the tool as described in the **Trigger** section of this manual determines the mode of operation.

SEQUENTIAL ACTION TRIGGER - / (GRAY)

The sequential action trigger's intended use is for intermittent nailing where very careful and accurate placement is desired.

To operate the nailer in sequential action mode:

1. Depress the contact trip firmly against the work surface.
2. Depress the trigger.

▲ CAUTION: A nail will fire each time the trigger is depressed as long as the contact trip remains depressed.

BUMP ACTION TRIGGER - // (BLACK)

The bump action trigger's intended use is for rapid nailing on flat, stationary surfaces.

Using the bump action trigger, two methods are available: **place actuation** and **bump actuation**.

To operate the tool using the PLACE ACTUATION method:

1. Depress the contact trip against the work surface.
2. Depress the trigger.

To operate the tool using the BUMP ACTUATION method:

1. Depress the trigger.
2. Push the contact trip against the work surface. As long as the trigger is depressed, the tool will fire a nail every time the contact trip is depressed. This allows the user to drive multiple nails in sequence.

▲ WARNING: Do not keep trigger depressed when tool is not in use. Keep the lock-off switch rotated to the right (OFF) when the tool is not in use.

FIG. 6A

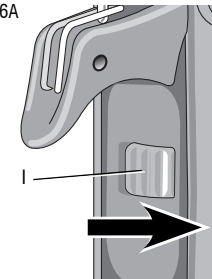
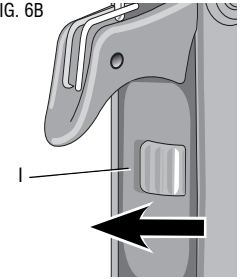

FIG. 6B



Adjusting Depth (Fig. 6)

▲ WARNING: To reduce risk of serious injury from accidental actuation when attempting to adjust depth, ALWAYS:

- Lock OFF trigger.
- Disconnect air supply.
- Avoid contact with trigger during adjustments.

The depth that the fastener is driven can be adjusted using the depth adjustment next to the trigger of the tool.

1. To drive the nail shallower, rotate the depth setting wheel (I) to the right (Fig. 6A).
2. To drive a nail deeper, rotate the depth setting wheel (I) to the left (Fig. 6B).

FIG. 7

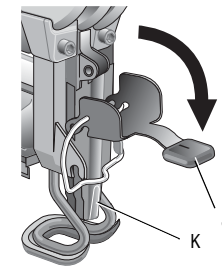

Clearing a Jammed Nail (Fig. 7)

▲ WARNING: Lock off trigger, disconnect air line from tool and remove fasteners from magazine before making adjustments or personal injury may result.

If a nail becomes jammed in the nosepiece, keep the tool pointed away from you and follow these instructions to clear:

1. Lock off trigger.
2. Disconnect air supply from tool and lock trigger.

- Release pusher from behind nails.
- Push down front latch (J) then pull up to open front door (K).
- Remove bent nail, using pliers if necessary.
- If driver blade is in the down position, insert screwdriver or other rod into nosepiece and push driver blade back in position.
- Remove rod and close front door.
- Lift latch to secure door to nosepiece.
- Reattach air supply.
- Reinsert nails into magazine (see Loading the Tool).
- Release pusher.

NOTE: Should nails continue to jam frequently in nosepiece, have tool serviced by an authorized DeWALT service center.

Cold Weather Operation

When operating tools at temperatures below freezing:

- Make sure compressor tanks have been properly drained prior to use.
- Keep tool as warm as possible prior to use.
- Make certain all fasteners have been removed from magazine.
- Lower air pressure to 80 psi (5.5 bar) or less.
- Reconnect air and load nails into magazine.
- Turn pressure up to operating level [not to exceed 120 psi (8.3 bar)] and use tool as normal.
- Always drain the compressor tanks at least once a daily.

NOTE: Please refer to *Preparing the Tool* under **Operation** if choosing to use oil.

Hot Weather Operation

Tool should operate normally. However, keep tool out of direct sunlight as excessive heat can deteriorate bumpers, o-rings and other rubber parts resulting in increased maintenance.

FIG. 8

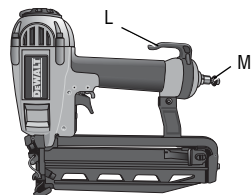

Belt Hook (Fig. 8)

The DeWALT nailers include an integrated belt hook (L) and can be rotated to either side of the tool to accommodate left- or right- handed users. It can also be rotated out of the way when not in use.

If the hook is not desired at all, it can be removed from the tool.

TO REMOVE BELT HOOK

- Lock off trigger.
- Disconnect the tool from air supply.
- Using the appropriate hex wrench, remove the end cap screws from the end cap (M) of the tool.
- Remove the belt hook.
- Replace end cap and gasket. Ensure that the three screws are tight.
- Replace and tighten air fitting.

MAINTENANCE

▲ WARNING: Lock off trigger, disconnect air line from tool and remove fasteners from magazine before making adjustments or personal injury may result.

Daily Maintenance Chart

ACTION	Drain compressor tanks and hoses daily.
WHY	Prevents accumulation of moisture in compressor and nailer.
HOW	Open petcocks or other drain valves on compressor tanks. Allow any accumulated water to drain from hoses.
ACTION	Clean magazine, pusher, and contact trip mechanism.
WHY	Permits smooth operation of magazine, reduces wear, and prevents jams.
HOW	Blow clean with compressor air. The use of oils, lubricants periodically or solvents is not recommended as they tend to attract debris.
ACTION	Before each use, check to insure all screws, nuts and fasteners are tight and undamaged.
WHY	Prevents jams, leaks and premature failure of tool parts.
HOW	Tighten loose screws or other fasteners using the appropriate hex wrench or screwdriver.

NOTE: Please refer to *Preparing the Tool* under **Operation** if choosing to use oil.

Cleaning

▲ WARNING: Blow dirt and dust out of all air vents with dry air at least once a week. Wear proper ANSI Z87.1 (CAN/CSA Z94.3) eye protection and proper NIOSH/OSHA/MSHA respiratory protection when performing this.

▲ WARNING: When cleaning, use only a damp cloth on non-metallic parts. Many household cleaners contain chemicals which could seriously damage non-metallic parts and o-rings. Also, do not use gasoline, turpentine, lacquer or paint thinner, dry cleaning fluids or similar products which may seriously damage non-metallic parts and o-rings. Never let any liquid get inside the tool; never immerse any part of the tool into a liquid.

Repairs

To assure product SAFETY and RELIABILITY, repairs, maintenance and adjustment (including brush inspection and replacement) should be performed by a DeWALT factory service center, a DeWALT authorized service center or other qualified service personnel. Always use identical replacement parts. Refer to the Troubleshooting Guide at the end of this section.

Accessories

▲ WARNING: Since accessories, other than those offered by DeWALT, have not been tested with this product, use of such accessories with this tool could be hazardous. To reduce the risk of injury, only DeWALT, recommended accessories should be used with this product.

Recommended accessories for use with your tool are available at extra cost from your local service center. If you need any assistance in locating any accessory, please contact DeWALT Industrial Tool Co., 20 Fletcher Road, Mooroolbark, VIC 3138 Australia or call 1800 654 155 or (NZ) 0800 339258.

Guarantee

Applicable to hand held Power Tools, Lasers and Nailers.

Three Year Limited Warranty

DeWALT will repair, without charge, any defects due to faulty materials or workmanship for three years from the date of purchase. Please return the complete unit, transportation prepaid, to any DeWALT Service Centre, or any authorised service station.

For warranty repair information, call (AUS) 1800 654 155 or (NZ) 0800 339258.

This warranty does not apply to

- Accessories
- Damage caused where repairs have been made or attempted by others.
- Damage due to misuse, neglect, wear and tear, alteration or modification.

This warranty gives you specific legal rights and you may have other rights under the provisions of the Consumer Guarantee Act 1993 (New Zealand only), Trade Practices Act 1974 and State Legislation (Australia only).

In addition to the warranty, DeWALT tools are covered by our:

FREE ONE YEAR SERVICE CONTRACT

DeWALT will also maintain the tool for free at any time during the first year of purchase. This includes labour, parts and lubrication required to restore the product to sound mechanical and/or electrical condition. Normal wear parts are not covered in this service. Carbon brushes worn more than 50% will be replaced.

NOTE: Three Year Warranty is not applicable to items deemed as consumables. Radial arm saws are covered by a one (1) year warranty only. DeWALT Reserves the right to review its warranty policy prior to launch of any new business development products.

30 DAY NO SATISFACTION GUARANTEE

If you are dissatisfied with any DeWALT power tool, laser or nailer, for any reason, simply return it to the point of purchase with your sales receipt within 30 days for a replacement unit or a full refund.

FREE WARNING LABEL REPLACEMENT: If your warning labels become illegible or are missing, call (AUS) 1800 654 155 or (NZ) 0800 339258 for a free replacement.

WARNING READ AND UNDERSTAND TOOL LABELS AND MANUAL. FAILURE TO FOLLOW WARNINGS COULD RESULT IN DEATH OR SERIOUS INJURY. OPERATORS AND OTHERS IN WORK AREA MUST WEAR ANSI Z87.1 SAFETY GLASSES WITH SIDE SHIELDS. KEEP FINGERS AWAY FROM TRIGGER WHEN NOT DRIVING FASTENERS TO AVOID ACCIDENTAL FIRING. CHOICE OF TRIGGERING METHOD IS IMPORTANT. CHECK MANUAL FOR TRIGGERING OPTIONS. NEVER DISABLE TRIGGER, CONTACT TRIP LOCK-OFF DEVICE. USE LOCK-OFF WHEN TOOL IS NOT IN USE. ENSURE TRIGGER AND CONTACT TRIP OPERATE PROPERLY BEFORE USE. NEVER POINT TOOL AT YOURSELF OR OTHERS IN WORK AREA. NEVER USE OXYGEN OR OTHER BOTTLED GASSES. EXPLOSION MAY OCCUR. DISCONNECT AIR BEFORE SERVICING TOOL. CLEARING JAMS, AND ADJUSTING DEPTH.
DeWALT Industrial Tool Co., Baltimore, MD 21286 U.S.A. For Service Information, Call 1-800-654155 www.DeWALT.com.au

DXXXXX-XE

FASTENER ANGLE	DIAMETER	LENGTH

TROUBLESHOOTING GUIDE

MANY COMMON PROBLEMS CAN BE SOLVED EASILY BY UTILIZING THE CHART BELOW. FOR MORE SERIOUS OR PERSISTENT PROBLEMS, CONTACT A DeWALT SERVICE CENTER OR CALL **1800 654 155 (Aust)** or **0800 339258 (NZ)**.

⚠ WARNING: To reduce the risk of serious personal injury, ALWAYS disconnect air from tool before all repairs.

Trigger valve housing leaks	O-ring or valve stem failure	Replace valve using: Trigger Valve Kit: Cat.# D510008
Top cap leaks air	Loose cap screws	Tighten cap screws using appropriate hex wrench
	Damaged or worn gasket or o-ring	Replace gasket/o-rings using: O-ring Repair Kit: Cat. # D512571 (16 GA.), D512761 (15 GA.)
Exhaust leaks	Main seal or o-ring damaged, debris in tool	Replace gasket/o-rings using: O-ring Repair Kit: Cat. # D512571 (16 GA.), D512761 (15 GA.)
Air leaks around nose when tool is at rest (Driver blade in up position)	Damaged or worn o-rings	Replace gasket/o-rings using: O-ring Repair Kit: Cat. # D512571 (16 GA.), D512761 (15 GA.)
Air leaks around nose when tool is in actuated position. (Driver blade in down position)	Damaged or worn bumper	Replace bumper using: Bumper Kit: Cat. # D512576 (16 GA.), D512763 (15 GA.)
Tool does not cycle in cold weather	Tool not receiving air	Check air supply
	Valve may be frozen	Warm up tool
	Damaged or worn o-rings	Replace gasket/o-rings using: O-ring Repair Kit: Cat. # D512571 (16 GA.), D512761 (15 GA.)
Lack of power; sluggish	Broken or damaged driver blade	Replace Driver Blade Kit: Cat. # D512575 (16 GA.), D512762 (15 GA.)
	Low air pressure	Check air supply
	Damaged or worn o-rings	Replace gasket/o-rings using: O-ring Repair Kit: Cat. # D512571 (16 GA.), D512761 (15 GA.)
Skipping fasteners; intermittent feed	Exhaust port blocked or clogged	Disconnect air, remove exhaust plate from top of tool, clean port
	Air restricted	Check air supply and couplers
	Nosepiece screws loose	Tighten nosepiece screws using appropriate hex wrench
Fasteners jam in tool	Wrong size/angle fasteners	Use only recommended fasteners
	Dirty magazine	Clean magazine track and nosepiece
	Worn magazine	Replace magazine
	Broken or damaged driver blade	Replace Driver Blade Kit: Cat. # D512575 (16 GA.), D512762 (15 GA.)
	Trigger valve o-ring worn or damaged	Replace valve using: Trigger Valve Kit: Cat. # D510008
	Worn piston o-ring	Replace piston o-ring using: O-Ring Repair Kit: Cat. # D512571 (16 GA.), D512761 (15 GA.)
	Worn or damaged pusher spring	Replace spring
	Magazine loose	Check that magazine latch is holding firmly
	Driver channel in nose piece worn	Replace nosepiece
	Wrong size/angle fasteners	Use only recommended fasteners
Magazine loose	Check that magazine screws are holding firmly	
Worn driver blade	Replace Driver Blade Kit: Cat. # D512575 (16 GA.), D512762 (15 GA.)	
Nosepiece screws loose	Tighten nosepiece screws using appropriate hex wrench	
Fasteners not feeding properly	Ensure fasteners are feeding properly into nose	

	Compressor will be sufficient for tools at all production rates.
	Compressor will be sufficient at slow or moderate production rates, but may have difficulty at very rapid rates.
	Compressor will be adequate only when tools are utilized at slow production rates. (punch-out or occasional use)
	Not Recommended
NR	

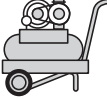
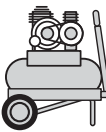
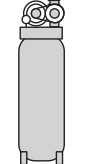
	Portable Handcarry 3.2 - 4 CFM 	5.5 HP Gas 2 HP Elec. 8 - 9 CFM 	8 HP Gas 14 - 16 CFM 	Industrial 23+ CFM 
1				
2				
3				
4	NR			
5	NR			
6	NR	NR		
7	NR	NR		
8+	NR	NR		

DEWALT Industrial Tool Co.,
20 Fletcher Road, Mooroolbark, VIC 3138 Australia (03 8720 5100) • 5 Te Apunga Place, Mt Wellington, New Zealand (0800 339258)
(DEC08) Part No. N005873 D51857-XE, D51876-XE Copyright © 2008 DEWALT

The following are trademarks for one or more DEWALT power tools: the yellow and black color scheme; the “D” shaped air intake grill; the array of pyramids on the handgrip; the kit box configuration; and the array of lozenge-shaped humps on the surface of the tool.